



## DESCRIPTION

- Ultra-compact 2-way system
- Wide projection pattern
- LF on angled baffles to maintain a wide upper/midrange beamwidth
- High output, high definition sound

## DESCRIPTION

The UB22z is engineered for extra-wide-angled coverage (horizontal) from a wall mounted position. This ultra-compact loudspeaker provides surprisingly high output and exceptional fidelity for near field applications. It is highly effective as a fill/delay element in larger overall systems or for foreground/background music reproduction as a stand-alone loudspeaker or in distributed systems.

Because they are compact and lightweight, UB22zs install quickly and easily in difficult spaces. As components of larger overall systems, the UB22z series can be used to provide underbalcony, overbalcony, and side box area coverage. Applications as fill/delay elements include large and small theatres and houses of worship. As a main system, they can be built into high definition, distributed systems for use in industrial or retail environments and as standalone or distributed loudspeakers for boardrooms, restaurants, offices, and transportation centers.

Foam-backed grilles hide the drivers from view for pleasing aesthetics. Side mounting points allow enclosures to be mounted in using accessory brackets. Additional mounting points accept an OmniMount® 30.0 Series or similar bracket. Standard colors are black and white. Other colors can be specified as a special order items.

Six year warranty.

## 2-WAY COMPACT FULL-RANGE

See *NOTES TABULAR DATA* for details

### CONFIGURATION

| Subsystem | Transducer                                       | Loading |
|-----------|--|---------|
| LF        | 2x 5.25 in cone                                  | Sealed  |
| HF        | 1x 1 in exit, 1 in voice coil compression driver | CD horn |

### Operating Mode

|            | Amplifier Channels | External Signal Processing |
|------------|--------------------|----------------------------|
| Single-amp | LF/HF              | HPF                        |

### PERFORMANCE <sup>1</sup>

**Operating Range** 85 Hz to 20 kHz

**Nominal Beamwidth** (*rotatable*)

|      |      |
|------|------|
| Horz | 120° |
| Vert | 50°  |

**Axial Sensitivity** (*whole space SPL*)

|       |       |                 |
|-------|-------|-----------------|
| LF/HF | 91 dB | 85 Hz to 20 kHz |
|-------|-------|-----------------|

**Input Impedance** (*ohms*)

|       | Nominal | Minimum      |
|-------|---------|--------------|
| LF/HF | 8       | 7.5 @ 280 Hz |

**Input Taps** (*MT versions*)

|       | 70 V               | 100 V       |
|-------|--------------------|-------------|
| LF/HF | 64 W / 32 W / 16 W | 64 W / 32 W |

**High Pass Filter**

|           |                                   |
|-----------|-----------------------------------|
| High Pass | =>55 Hz, 12 dB/octave Butterworth |
|-----------|-----------------------------------|

**Accelerated Life Test** <sup>2</sup>

|       |      |               |
|-------|------|---------------|
| LF/HF | 40 V | 200 W @ 8 ohm |
|-------|------|---------------|

**Calculated Axial Output Limit** (*whole space SPL*)

|       | Average | Peak   |
|-------|---------|--------|
| LF/HF | 114 dB  | 120 dB |

### ORDERING DATA

| Description                                | Part Number |
|--|-------------|
| UB22z 2-Way Full-Range Loudspeaker Black   | 0013733     |
| UB22z 2-Way Full-Range Loudspeaker White   | 0017844     |
| UB22zMT w/64 W Xfmr Black                  | 0013734     |
| UB22zPL-WP Weather-protected               | 0013736     |
| UB22zMTPL-WP Weather-protected w/64 W Xfmr | 0013735     |
| <b>Optional Accessories</b>                |             |
| Aluminum U-bracket Kit Black               | 0015342     |
| Aluminum U-bracket Kit White               | 0015830     |

<sup>1</sup> To achieve specified performance, the listed external signal processing with EAW-provided settings is required.

<sup>2</sup> For recommendations to select power amplifier size refer to: "HOW MUCH AMPLIFIER POWER DO I NEED?" on the EAW web site.

# UB22z Specifications

## ENCLOSURE

|          |   |
|----------|---|
| Material | Baltic birch plywood (Celtec® for PL-WP versions) |
| Finish   | Wear resistant textured black paint               |
| Grille   | Powder-coated perforated steel with foam backing  |

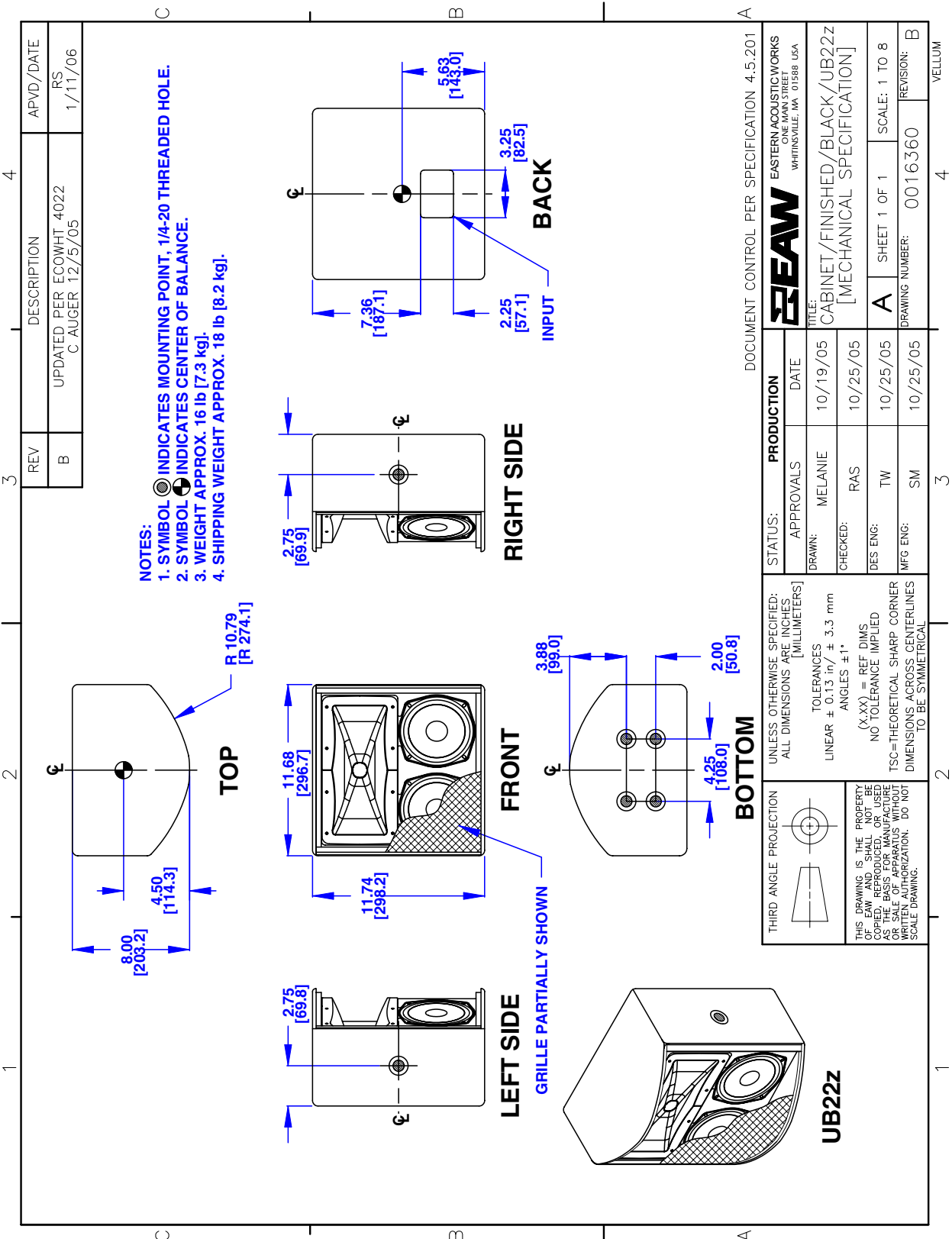

**NOTE:** This drawing has been reduced. Do not scale.  
For WP version, add 0.25 in / 6.4 mm to the outside dimensions = 0.125 in / 3.2 mm all around.

# UB22z Specifications

## PERFORMANCE DATA

See **NOTES GRAPHIC DATA** for details

### Frequency Response: Processed

Single-amp = blue

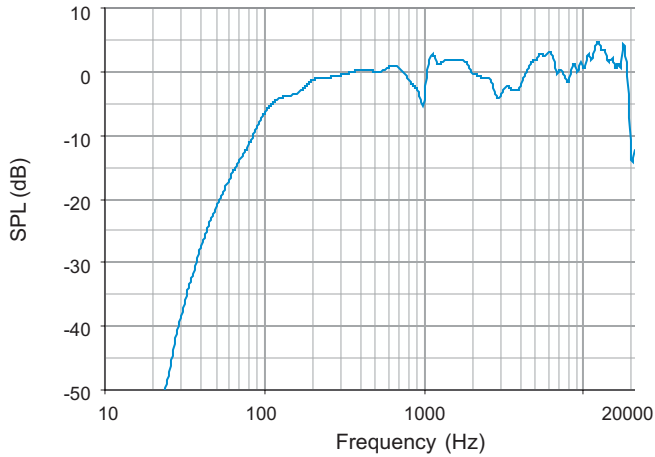

### Frequency Response: Unprocessed

Single-amp = blue

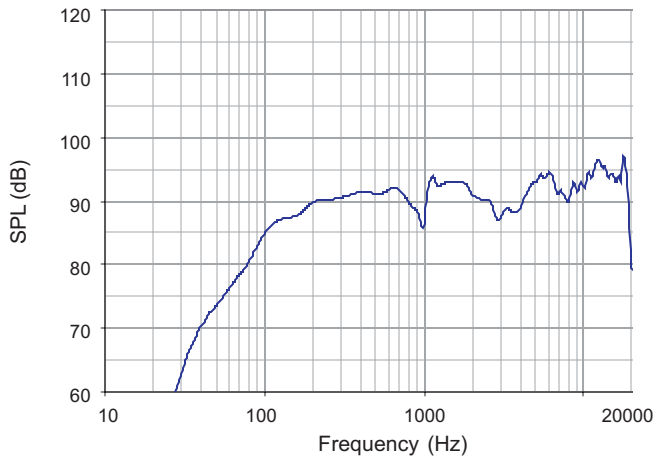

### Frequency Response: Digital Signal Processor

Single-amp = blue

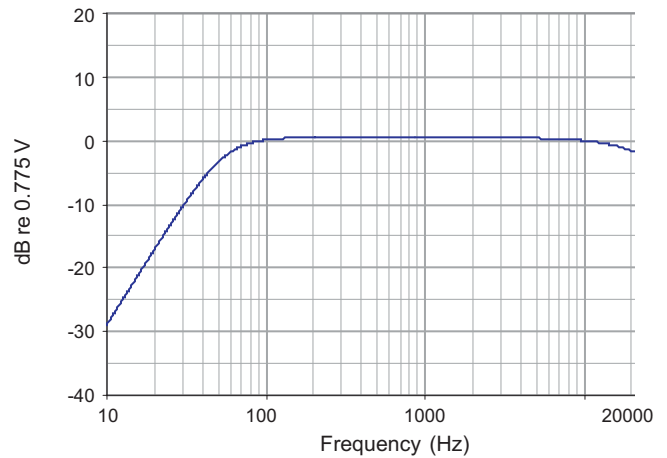

### Impedance Magnitude

LF = green, MF/HF = black, Single-amp = blue

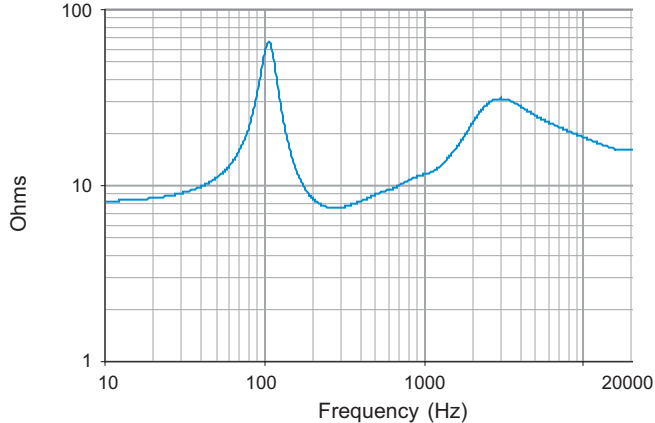

### Beamwidth (-6 dB SPL Points)

Horizontal = orange Vertical = black

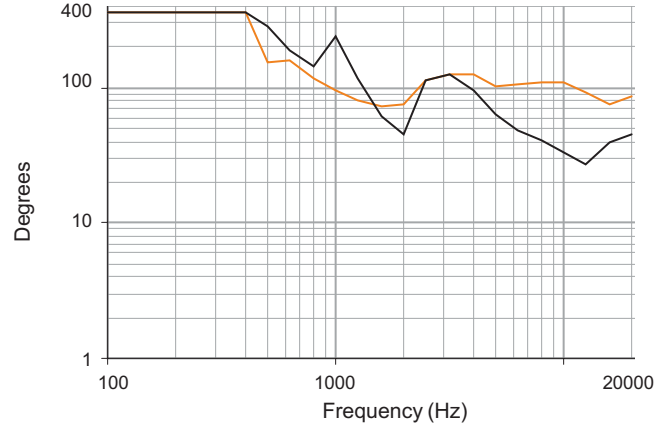

# UB22z Specifications

## HORIZONTAL POLAR DATA (Gridlines: 6 dB axial / 15 degree radial)

See **NOTES GRAPHIC DATA** for details

100 Hz  
125 Hz  
160 Hz  
200 Hz

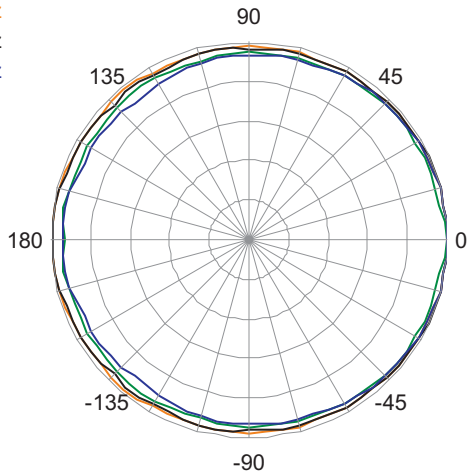

1600 Hz  
2000 Hz  
2500 Hz  
3150 Hz

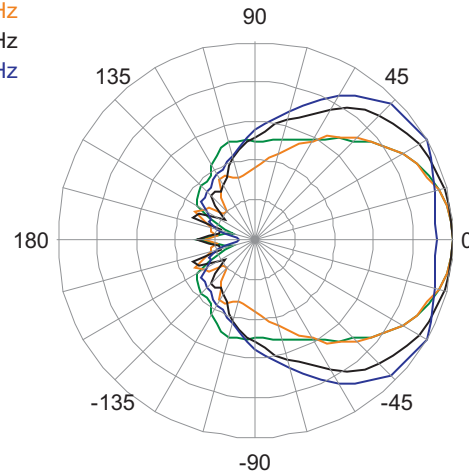

250 Hz  
315 Hz  
400 Hz  
500 Hz

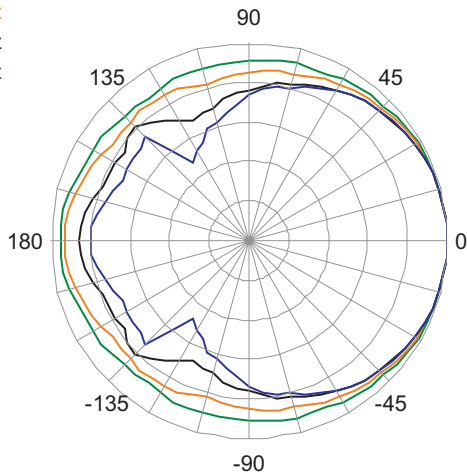

4000 Hz  
5000 Hz  
6300 Hz  
8000 Hz

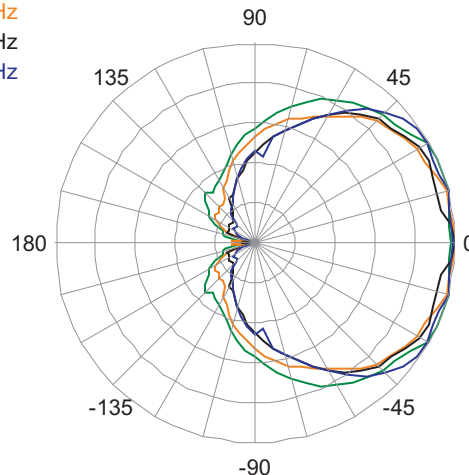

630 Hz  
800 Hz  
1000 Hz  
1250 Hz

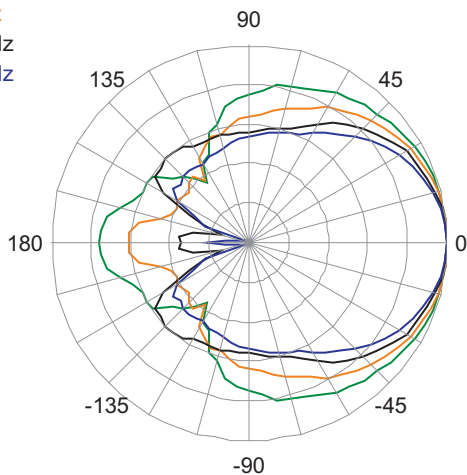

10000 Hz  
12000 Hz  
16000 Hz

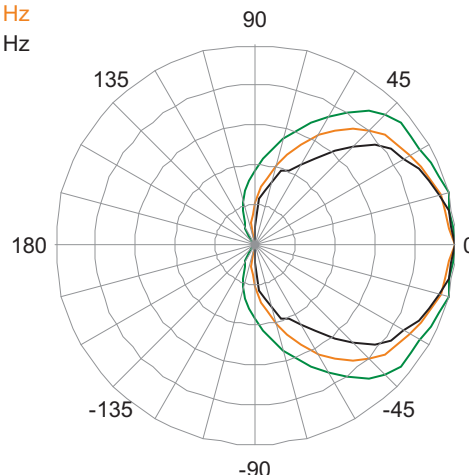

# UB22z Specifications

## VERTICAL POLAR DATA (Gridlines: 6 dB axial / 15 degree radial)

See **NOTES GRAPHIC DATA** for details

100 Hz  
125 Hz  
160 Hz  
200 Hz

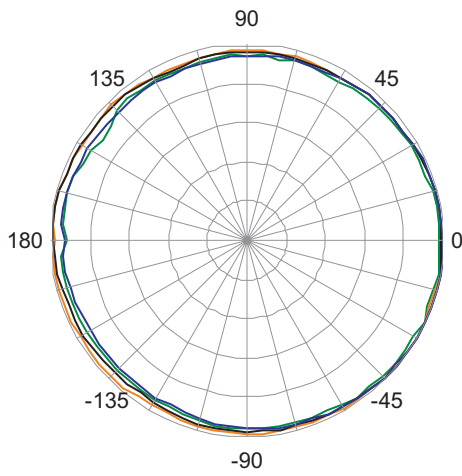

1600 Hz  
2000 Hz  
2500 Hz  
3150 Hz

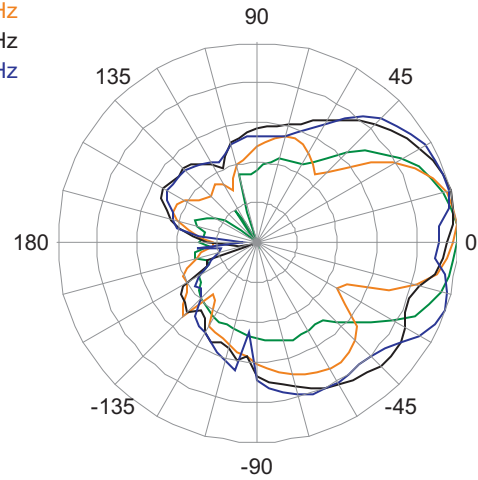

250 Hz  
315 Hz  
400 Hz  
500 Hz

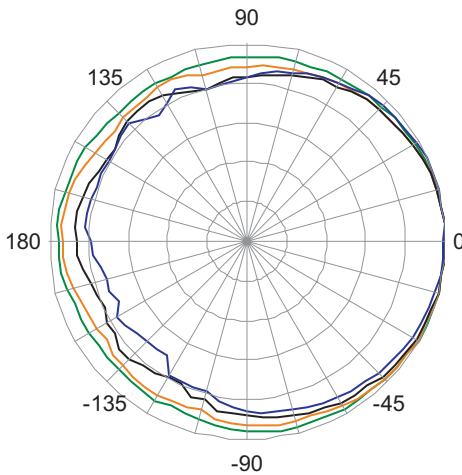

4000 Hz  
5000 Hz  
6300 Hz  
8000 Hz

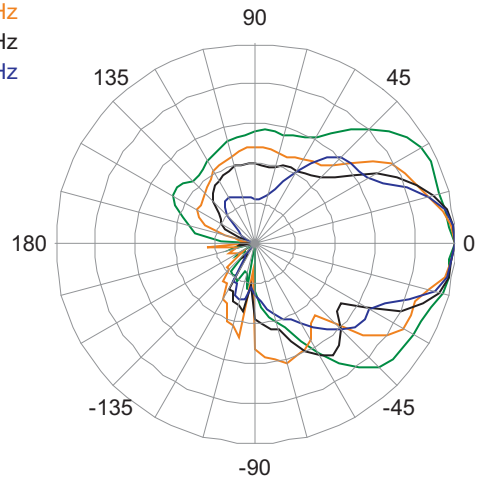

630 Hz  
800 Hz  
1000 Hz  
1250 Hz

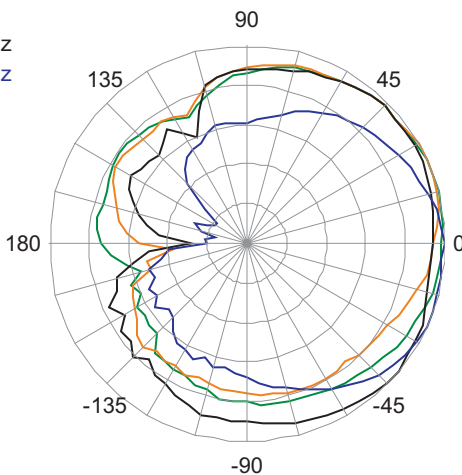

10000 Hz  
12000 Hz  
16000 Hz

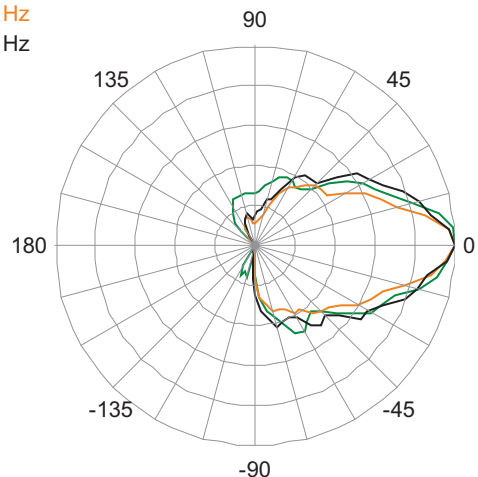

# UB22z Specifications

## INPUT PANEL

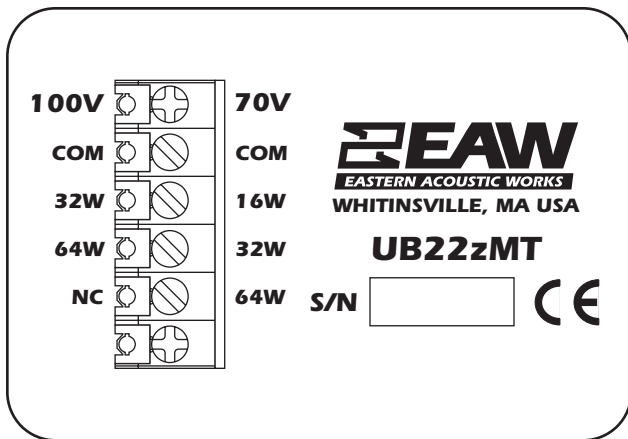
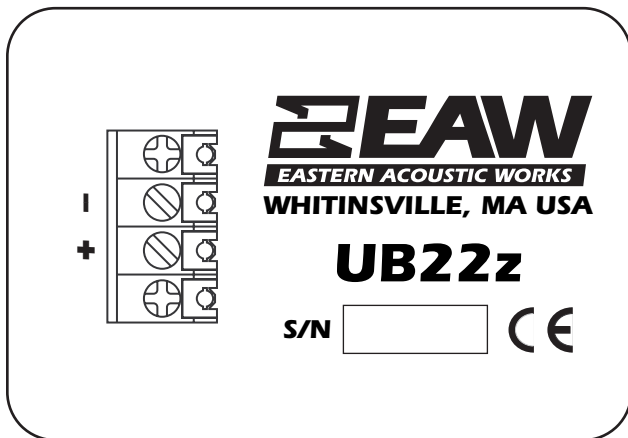

## SIGNAL DIAGRAM

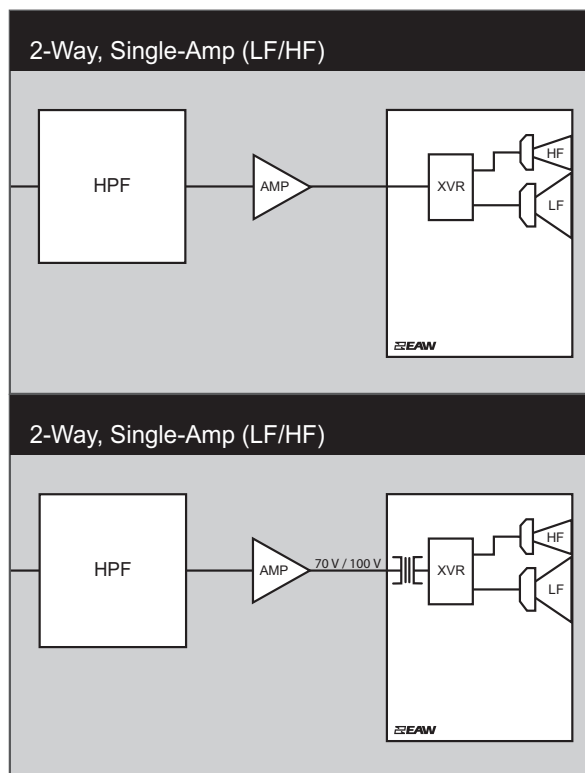

## LEGEND

- DSP:** User-supplied Digital Signal Processor.
- HPF:** High Pass Filter for crossover or Recommended High Pass Filter.
- LPF:** Low Pass Filter for crossover.
- LF/MF/HF:** Low Frequency / Mid Frequency / High Frequency.
- AMP:** User-supplied Power Amplifier.
- XVR:** Passive LPFs, HPFs, and EQ integral to the loudspeaker.

## NOTES

### TABULAR DATA

1. **Measurement/Data Processing Systems:** Primary - FChart: proprietary EAW software; Secondary - Brüel & Kjær 2012.
2. **Microphone Systems:** Earthworks M30; Brüel & Kjær 4133
3. **Measurements:** Dual channel FFT; length: 32 768 samples; sample rate: 48 kHz; logarithmic sine wave sweep.
4. **Measurement System Qualification** (includes all uncertainties): SPL: accuracy +/-0.2 dB @ 1 kHz, precision +/-0.5 dB 20 Hz to 20 kHz, resolution 0.05 dB; Frequency: accuracy +/-1 %, precision +/-0.1 Hz, resolution the larger of 1.5 Hz or 1/48 octave; Time: accuracy +/-10.4 µs, precision +/-0.5 µs, resolution 10.4 µs; Angular: accuracy +/-1°, precision +/-0.5°, resolution 0.5°.
5. **Environment:** Measurements time-windowed and processed to eliminate room effects, approximating an anechoic environment. Data processed as anechoic or fractional space, as noted.
6. **Measurement Distance:** 7.46 m. Acoustic responses represent complex summation of the subsystems at 20 m. SPL is referenced to other distances using the Inverse Square Law.
7. **Enclosure Orientation:** For beamwidth and polar specifications, as shown in Mechanical Specification drawing.
8. **Volts:** Measured rms value of the test signal.
9. **Watts:** Per audio industry practice, "loudspeaker watts" are calculated as voltage squared divided by rated nominal impedance. Thus, these are not True Watt units of energy as defined by International Standard.
10. **SPL:** (Sound Pressure Level) Equivalent to the average level of a signal referenced to 0 dB SPL = 20 microPascals.
11. **Subsystem:** This lists the transducer(s) and their acoustic loading for each passband. Sub = Subwoofer, LF = Low Frequency, MF = Mid Frequency, HF = High Frequency.
12. **Operating Mode:** User selectable configurations. Between system elements, a comma (,) = separate amplifier channels; a slash (/) = single amplifier channel. DSP = Digital Signal Processor. IMPORTANT: To achieve the specified performance, the listed external signal processing must be used with EAW-provided settings.
13. **Operating Range:** Range where the processed Frequency Response stays within -10 dB SPL of the power averaged SPL within this range; measured on the geometric axis. Narrow band dips are accepted.
14. **Nominal Beamwidth:** Design angle for the -6 dB SPL points, referenced to 0 dB SPL as the highest level.
15. **Axial Sensitivity:** Power averaged SPL over the Operating Range with an input voltage that would produce 1 W at the nominal impedance; measured with no external processing on the geometric axis, referenced to 1 m.
16. **Nominal Impedance:** Selected 4, 8, or 16 ohm resistance such that the minimum impedance point is no more than 20% below this resistance over the Operating Range.
17. **Accelerated Life Test:** Maximum test input voltage applied with an EIA-426B defined spectrum; measured with recommended signal processing and Recommended Protection Filter.
18. **Calculated Axial Output Limit:** Highest average and peak SPLs possible during the Accelerated Life Test. The Peak SPL represents the 2:1 (6 dB) crest factor of the Life Test signal.
19. **High Pass Filter:** This helps protect the loudspeaker from excessive input signal levels at frequencies below the Operating Range.

### GRAPHIC DATA

1. **Resolution:** To remove insignificant fine details, 1/12 octave cepstral smoothing was applied to acoustic frequency responses and 1/3 octave cepstral smoothing was applied to the beamwidth and impedance data. Other graphs are plotted using raw data.
2. **Frequency Responses:** Variation in acoustic output level with frequency for a constant input signal. Processed: normalized to 0 dB SPL. Unprocessed inputs: 2 V (4 ohm nominal impedance), 2.83 V (8 ohm nominal impedance), or 4 V (16 ohm nominal impedance) referenced to a distance of 1 m.
3. **Processor Response:** The variation in output level with frequency for a constant input signal of 0.775 V = 0 dB reference.
4. **Beamwidth:** Average angle for each 1/3 octave frequency band where, starting from the rear of the loudspeaker, the output first reaches -6 dB SPL referenced to 0 dB SPL as the highest level. This method means the output may drop below -6 dB SPL within the beamwidth angle.
5. **Impedance:** Variation in impedance magnitude, in ohms, with frequency without regard to voltage/current phase. This means the impedance values may not be used to calculate True Watts (see 9 above).
6. **Polar Data:** Horizontal and vertical polar responses for each 1/3 octave frequency band 100 Hz to 16 kHz or Operating Range.