



FEATURES

- High output, single or bi-amplified, two-way performance
- Broadband pattern control
- Ultra-efficient HF compression driver
- Four Phase Aligned™ 10-in cone transducers (vertical and horizontal pairs)
- Installation flexibility, compact size

DESCRIPTION

The new QX300 Series design delivers great output and renowned broadband pattern control similar to the QX500 Series three-way but in a new compact two-way format. Its large 4-in voice coil high frequency compression driver makes it possible to cover the mid-range frequencies. Its high output level makes it appropriate for medium throws in arenas and stadiums or high-energy applications like live music venues or dance clubs. Its broadband pattern control lets it tame hostile acoustical environments like cathedrals or highly reverberant public spaces. And its exceptional fidelity pleases the most critical listeners in concert halls and performing arts centers.

The QX364 has an ultra-efficient and unique high compression driver with a 60° x 45° constant directivity horn (one of six horn patterns available, ranging from 60° x 45° to 120° x 60°). Four Phase Aligned™ 10-in low frequency transducers arranged as vertical and horizontal pairs leverage beneficial interaction based on their spacing to extend pattern control.

Because the four low frequency transducers surround the high compression driver symmetrically in the horizontal and vertical planes, response across the full frequency spectrum appears to originate from a single point in space.

Users can select between single-amp and bi-amp operating modes. Additionally, each woofer pair is brought out to the input plate independently to permit independent, series, or parallel wiring. Combined, these features offer enormous installation flexibility.

Six year warranty.

2-WAY FULL-RANGE LOUDSPEAKER 60° x 45°

See *NOTES TABULAR DATA* for details

CONFIGURATION

Subsystem:

	Transducer	Loading
LF	4x 10-in cone	Phase-Aligned™
HF	1x 1.4-in exit, 4-in voice coil compression driver	Horn-loaded

Operating Mode:

	Amplifier Channels	External Signal Processing
Single-amp	LF/HF	DSP w/EAW Focusing
Bi-amp	LF, HF	DSP w/EAW Focusing

PERFORMANCE

Operating Range: 66 Hz to 20 kHz

Nominal Beamwidth:

Horz 60°
Vert 45°

Axial Sensitivity (whole space SPL):

LF/HF	109 dB	70 Hz to 20 kHz
LF	102 dB	66 Hz to 600 Hz
HF	111 dB	500 Hz to 20 kHz

Input Impedance (ohms):

	Nominal	Minimum
LF/HF	8	6.4 @ 175 Hz
LF1, LF2 (each)	4	4 @ 460 Hz
LF (total)	2	2 @ 460 Hz
HF	8	7.9 @ 720 Hz

High Pass Filter: High Pass =>70 Hz, 12 dB/octave Butterworth

Accelerated Life Test:

LF/HF	80 V	800W @ 8 ohm
LF1, LF2 (each)	60 V	900W @ 4 ohm
LF (total)	60 V	1800W @ 2 ohm
HF	35 V	150 W @ 8 ohm

Calculated Axial Output Limit (whole space SPL):

	Average	Peak
LF/HF	138 dB	144 dB
LF	135 dB	141 dB
HF	133 dB	139 dB

ORDERING DATA

Description	Part Number
EAW QX364 2-Way Full-Range Loudspeaker Black	2040494
EAW QX364 2-Way Full-Range Loudspeaker White	2042376
EAW QX364-WP 2-Way Full-Range Loudspeaker Black	2042385

Optional Accessories

U-Bracket Horizontal QX3 Black [UBKT-QX3H]	2042189
Adapter Bracket QX Black [ACC-ABQX]	2036437
Weather Protection Shield [ACC-WPSQX3]	2042373

ENCLOSURE

Material Exterior Grade Baltic Birch Plywood
 Finish Wear resistant textured black paint
 Grille Powder-coated perforated steel

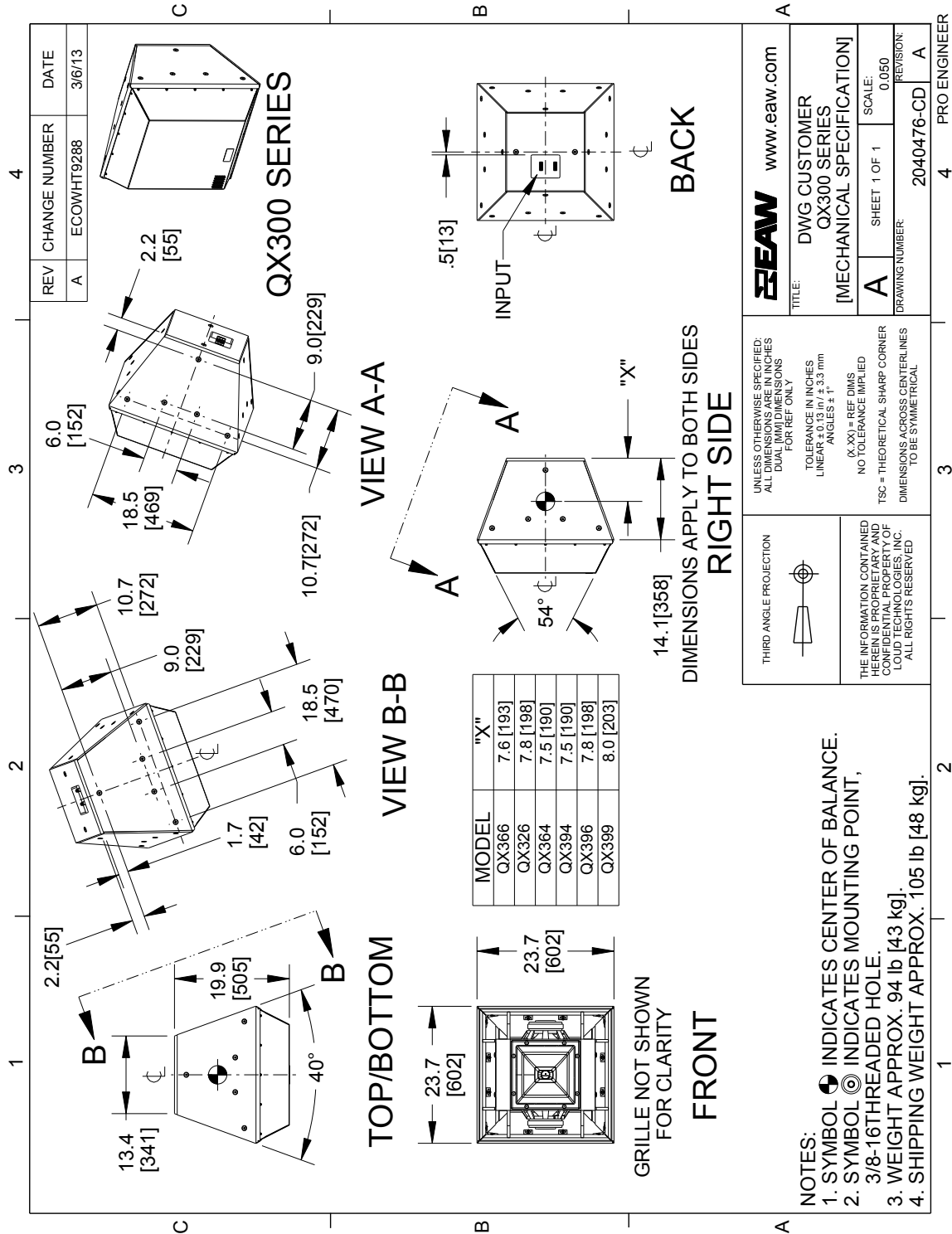

NOTE: This drawing has been reduced. Do not scale.

PERFORMANCE DATA

See NOTES GRAPHIC DATA for details

Frequency Response: Processed

LF = green, HF = black, Complete = blue

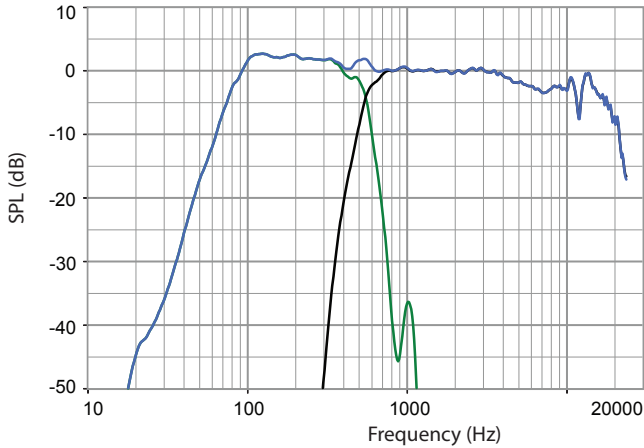

Frequency Response: Unprocessed

LF = green, HF = black, Complete = blue

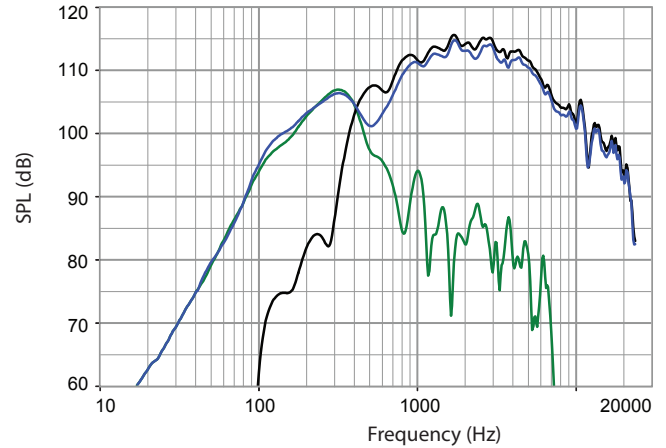

Impedance

LF = green, HF = black, Complete = blue

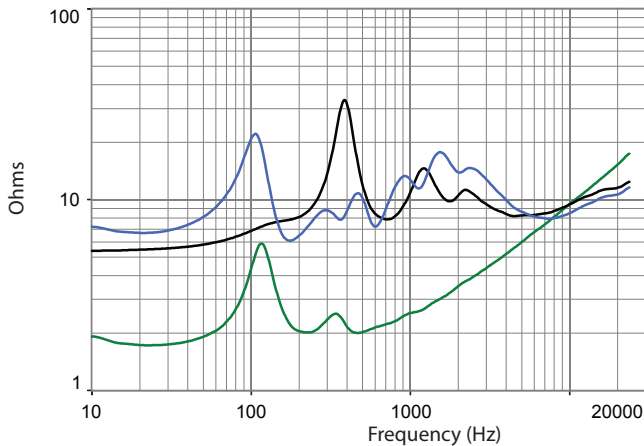

Phase Linearity

Complete = blue

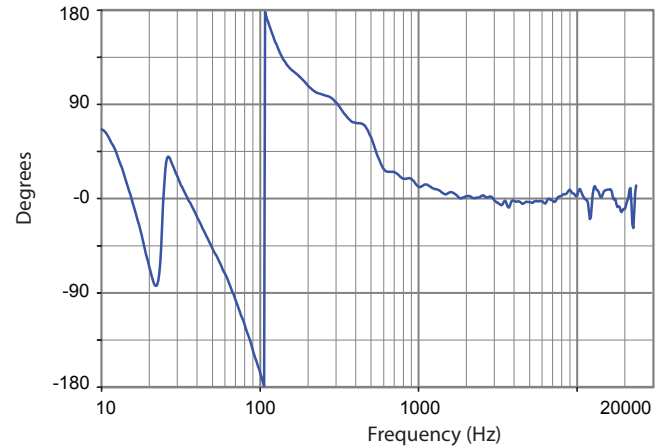

Beamwidth

Horizontal = orange Vertical = black

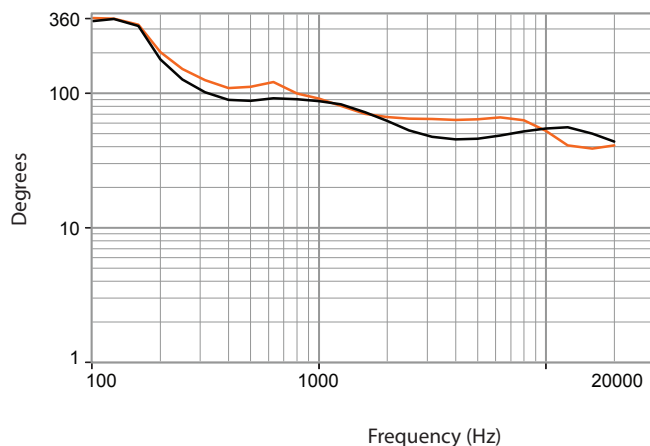

HORIZONTAL POLAR DATA

See NOTES GRAPHIC DATA for details

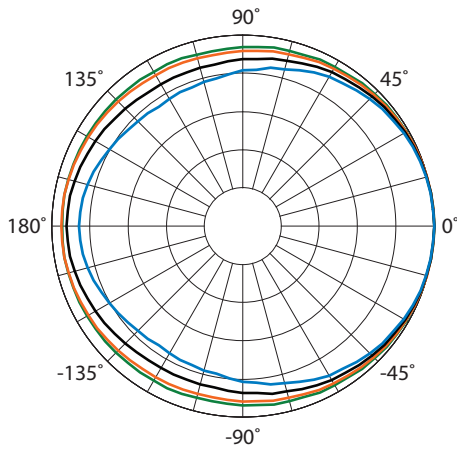

- 100Hz
- 125Hz
- 160Hz
- 200Hz

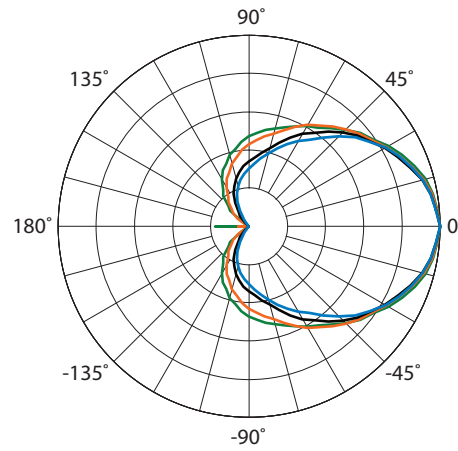

- 1600Hz
- 2000Hz
- 2500Hz
- 3150Hz

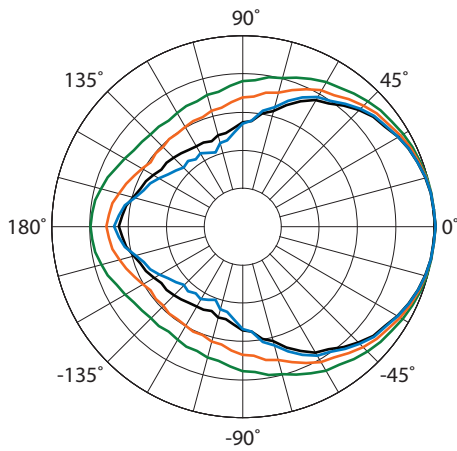

- 250Hz
- 315Hz
- 400Hz
- 500Hz

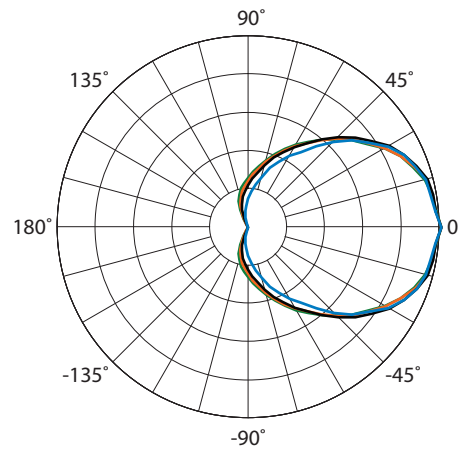

- 4000Hz
- 5000Hz
- 6300Hz
- 8000Hz

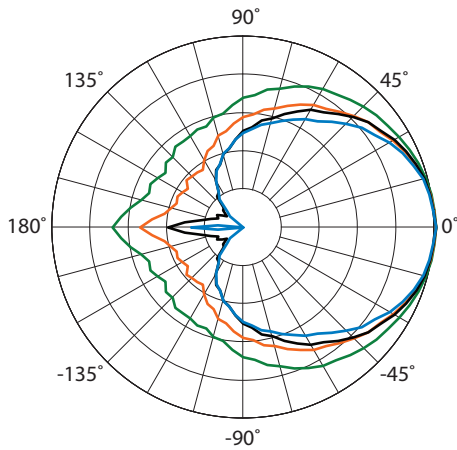

- 630Hz
- 800Hz
- 1000Hz
- 1250Hz

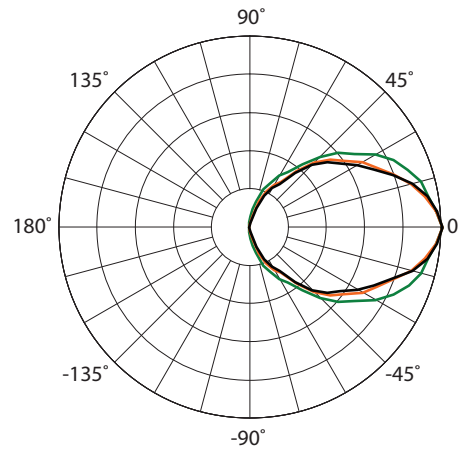

- 10000Hz
- 12500Hz
- 16000Hz

VERTICAL POLAR DATA

See NOTES GRAPHIC DATA for details

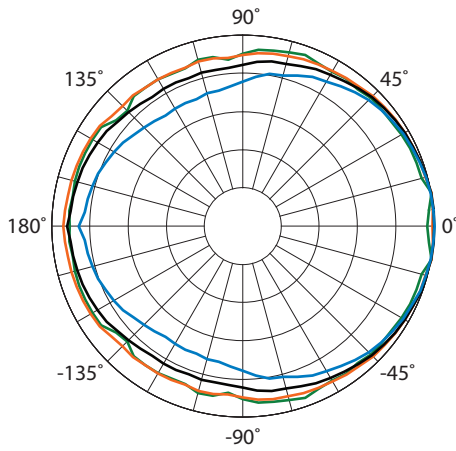

- 100Hz
- 125Hz
- 160Hz
- 200Hz

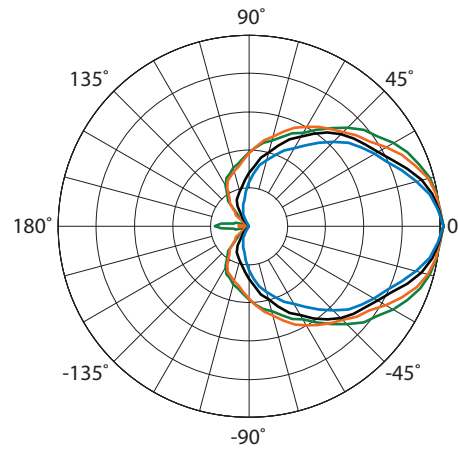

- 1600Hz
- 2000Hz
- 2500Hz
- 3150Hz

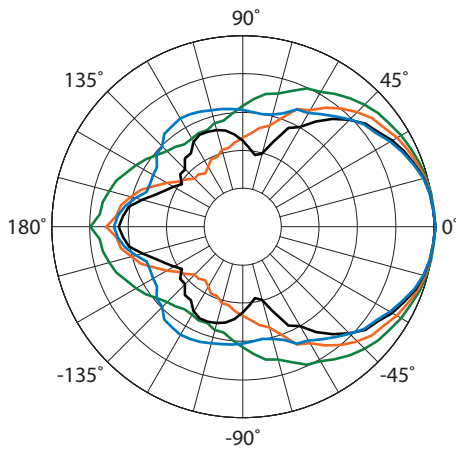

- 250Hz
- 315Hz
- 400Hz
- 500Hz

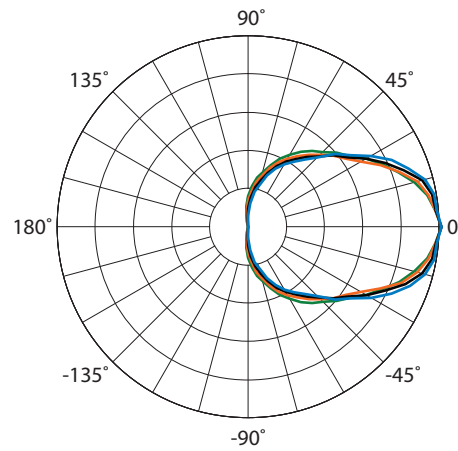

- 4000Hz
- 5000Hz
- 6300Hz
- 8000Hz

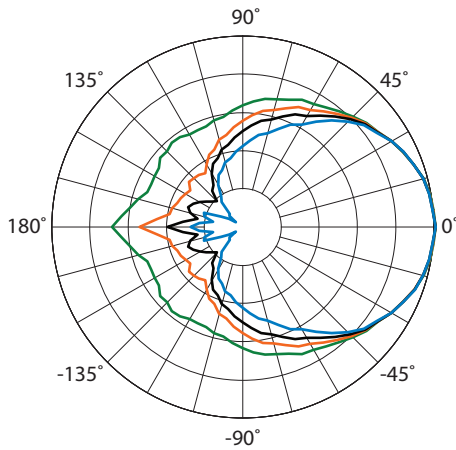

- 630Hz
- 800Hz
- 1000Hz
- 1250Hz

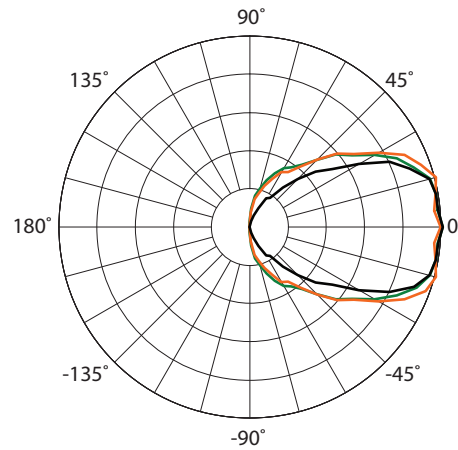

- 10000Hz
- 12500Hz
- 16000Hz

INPUT PANEL

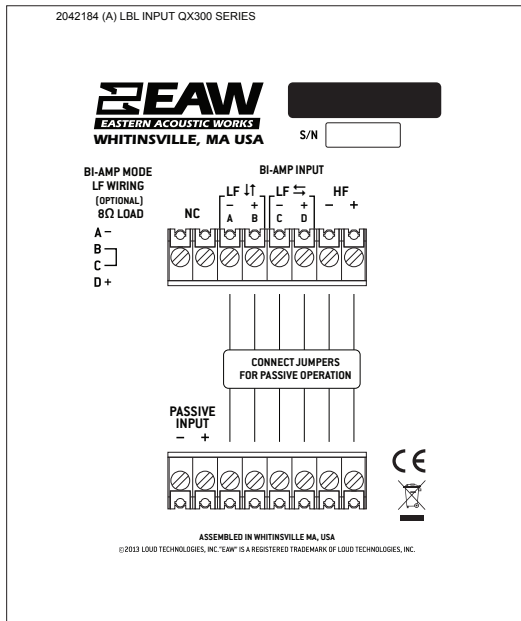

SIGNAL DIAGRAM

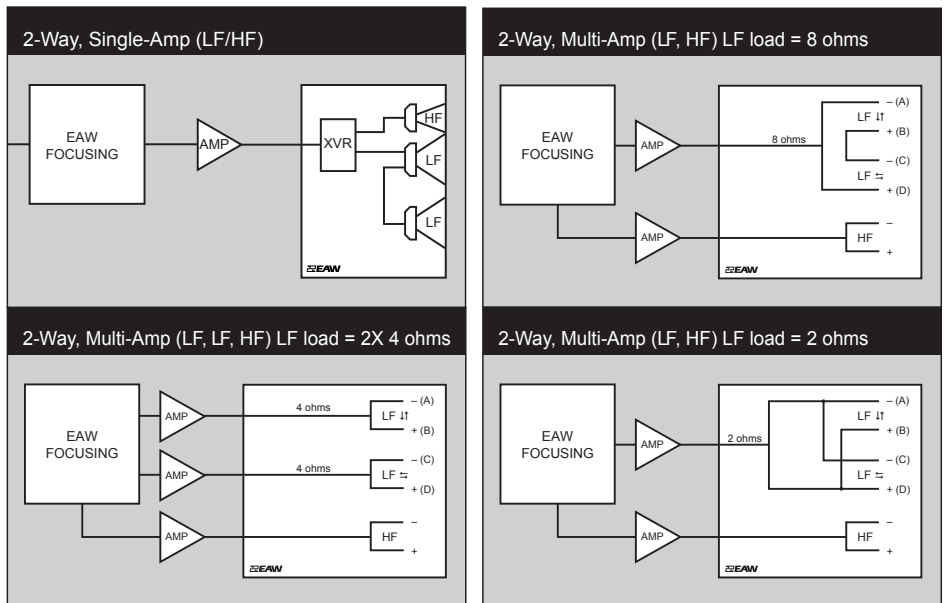

LEGEND

HPF:	High Pass Filter for crossover –or– Recommended High Pass Filter.
LPF:	Low Pass Filter for crossover.
LF/MF/HF:	Low Frequency / Mid Frequency / High Frequency.
AMP:	User Supplied Power Amplifier –or– Integral Amplifier for NT products.
XVR:	Passive LPFs, HPFs, and EQ integral to the loudspeaker.
EAW Focusing:	Digital Signal Processor capable of implementing EAW Focusing.

NOTES

TABULAR DATA

1. Measurement/Data Processing Systems: Primary - FChart; proprietary EAW software; Secondary - Brüel & Kjær 2012.
2. Microphone Systems: Earthworks M30; Brüel & Kjær 4133
3. Measurements: Dual channel FFT; length: 32 768 samples; sample rate: 48 kHz; logarithmic sine wave sweep.
4. Measurement System Qualification (includes all uncertainties): SPL: accuracy +/-0.2 dB @ 1 kHz, precision +/-0.5 dB 20 Hz to 20 kHz, resolution 0.05 dB; Frequency: accuracy +/-1 %, precision +/-0.1 Hz, resolution the larger of 1.5 Hz or 1/48 octave; Time: accuracy +/-10.4 µs, precision +/-0.5 µs, resolution 10.4 µs; Angular: accuracy +/-1°, precision +/-0.5°, resolution 0.5°.
5. Environment: Measurements time-windowed and processed to eliminate room effects, approximating an anechoic environment. Data processed as anechoic or fractional space, as noted.
6. Measurement Distance: 7.46 m. Acoustic responses represent complex summation of the subsystems at 20 m. SPL is referenced to other distances using the Inverse Square Law.
7. Enclosure Orientation: For beamwidth and polar specifications, as shown in Mechanical Specification drawing.
8. Volts: Measured rms value of the test signal.
9. Watts: Per audio industry practice, "loudspeaker watts" are calculated as voltage squared divided by rated nominal impedance. Thus, these are not True Watt units of energy as defined by International Standard.
10. SPL: (Sound Pressure Level) Equivalent to the average level of a signal referenced to 0 dB SPL = 20 microPascals.
11. Subsystem: This lists the transducer(s) and their acoustic loading for each passband. Sub = Subwoofer, LF = Low Frequency, MF = Mid Frequency, HF = High Frequency.
12. Operating Mode: User selectable configurations. Between system elements, a comma (,) = separate amplifier channels; a slash (/) = single amplifier channel. DSP = Digital Signal Processor. IMPORTANT: To achieve the specified performance, the listed external signal processing must be used with EAW-provided settings.
13. Operating Range: Range where the processed Frequency Response stays within -10 dB SPL of the power averaged SPL within this range; measured on the geometric axis. Narrow band dips are excepted.
14. Nominal Beamwidth: Design angle for the -6 dB SPL points, referenced to 0 dB SPL as the highest level.
15. Axial Sensitivity: Power averaged SPL over the Operating Range with an input voltage that would produce 1 W at the nominal impedance; measured with no external processing on the geometric axis, referenced to 1 m.
16. Nominal Impedance: Selected 4, 8, or 16 ohm resistance such that the minimum impedance point is no more than 20% below this resistance over the Operating Range.
17. Accelerated Life Test: Maximum test input voltage applied with an EIA-426B defined spectrum; measured with recommended signal processing and Recommended Protection Filter.
18. Calculated Axial Output Limit: Highest average and peak SPLs possible during the Accelerated Life Test. The Peak SPL represents the 2:1 (6 dB) crest factor of the Life Test signal.
19. High Pass Filter: This helps protect the loudspeaker from excessive input signal levels at frequencies below the Operating Range.

GRAPHIC DATA

1. Resolution: To remove insignificant fine details, 1/12 octave cepstral smoothing was applied to acoustic frequency responses and 1/3 octave cepstral smoothing was applied to the beamwidth and impedance data. Other graphs are plotted using raw data.
2. Frequency Responses: Variation in acoustic output level with frequency for a constant input signal. Processed: normalized to 0 dB SPL. Unprocessed inputs: 2 V (4 ohm nominal impedance), 2.83 V (8 ohm nominal impedance), or 4 V (16 ohm nominal impedance) referenced to a distance of 1 m.
3. Processor Response: The variation in output level with frequency for a constant input signal of 0.775 V = 0 dB reference.
4. Beamwidth: Average angle for each 1/3 octave frequency band where, starting from the rear of the loudspeaker, the output first reaches -6 dB SPL referenced to 0 dB SPL as the highest level. This method means the output may drop below -6 dB SPL within the beamwidth angle.
5. Impedance: Variation in impedance magnitude, in ohms, with frequency without regard to voltage/current phase. This means the impedance values may not be used to calculate True Watts (see 9 above).
6. Polar Data: Horizontal and vertical polar responses for each 1/3 octave frequency band 100 Hz to 16 kHz or Operating Range.